

DO NOT SCALE
REMOVE ALL SHARP EDGES

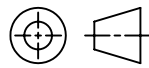

REV DETAILS

INITIALS

DATE

NOT TO BE USED FOR CONSTRUCTION

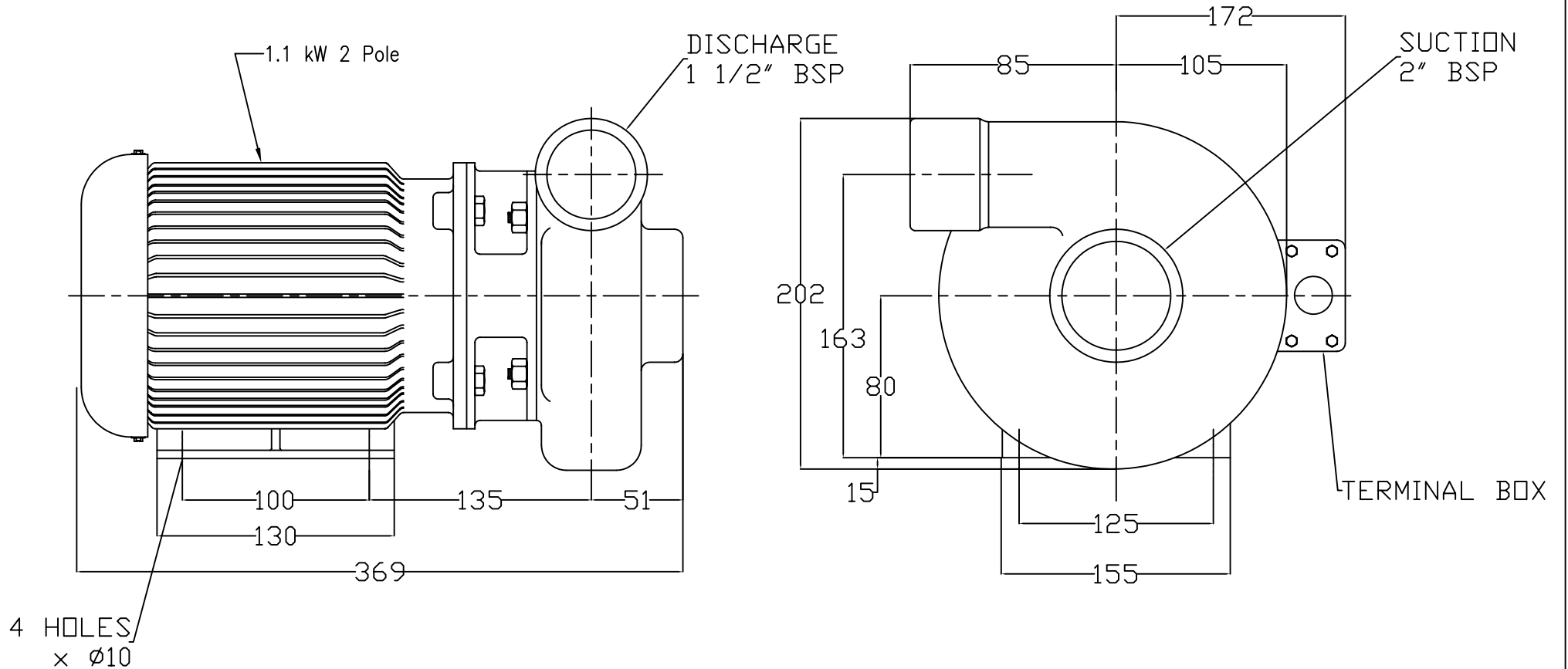

ITEM	DETAILS	TOLERANCES (UNLESS OTHERWISE SPECIFIED)	TITLE	SUPPLIER	QTY
	UNLESS OTHERWISE STATED ALL DIMENSIONS IN MILLIMETRES DO NOT SCALE DRAWING THIRD ANGLE PROJECTION	LINEAR X ± 0.5 X.X ± 0.05	ANGULAR X $\pm 0.5^\circ$	GENERAL ARRANGEMENT Superflow	
			MODEL 40-95/18-T2	DRAWING NO	
			SCALE N.T.S.	SHEET 1 OF 1	SHEET SIZE A3
			DATE 22-07-2002		